

# A3

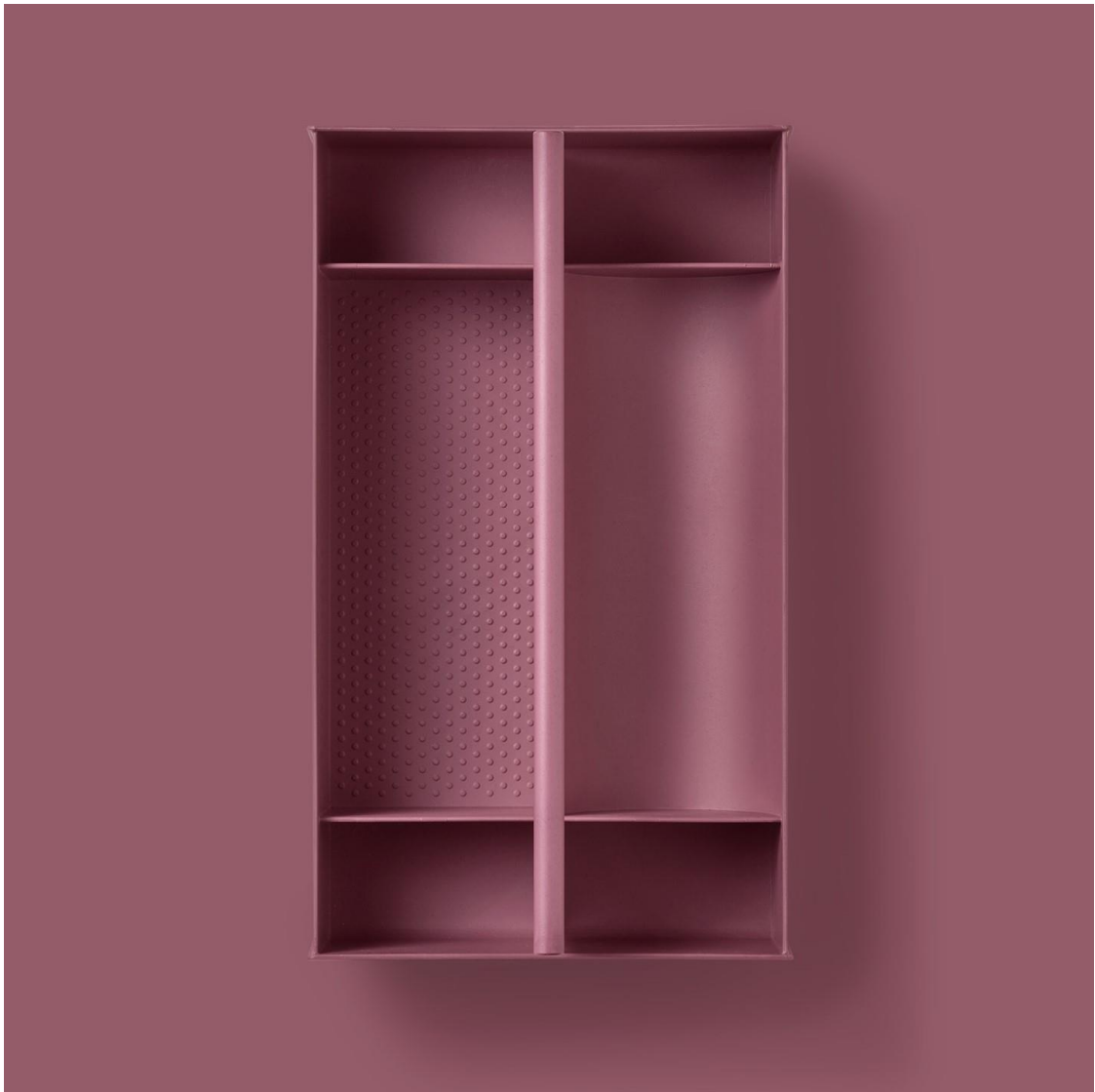

SERIES A3

TOOLBOX A3.21

AVAILABLE IN:  
NORDIC GREEN,  
DARK BURGUNDY  
CORAL

THE MATERIAL IS BASED ON STARCH FROM MAIZE AND  
SWEET POTATO, WITH BAMBOO FIBRE REINFORCEMENT.  
IT IS NON-TOXIC, NATURALLY DEGRADABLE AND COMPOSIBLE.

DESIGN BY NOTE DESIGN STUDIO

[WWW.HAVEN.SE](http://WWW.HAVEN.SE)

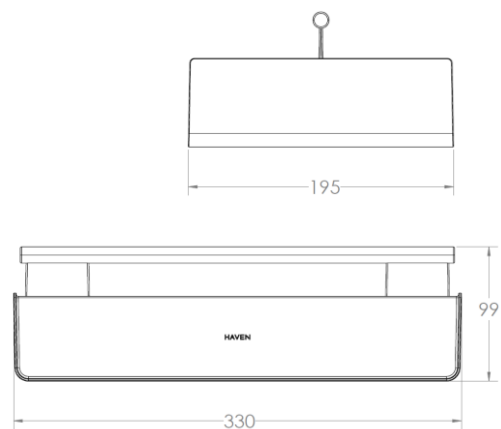

# HAVEN

# A3

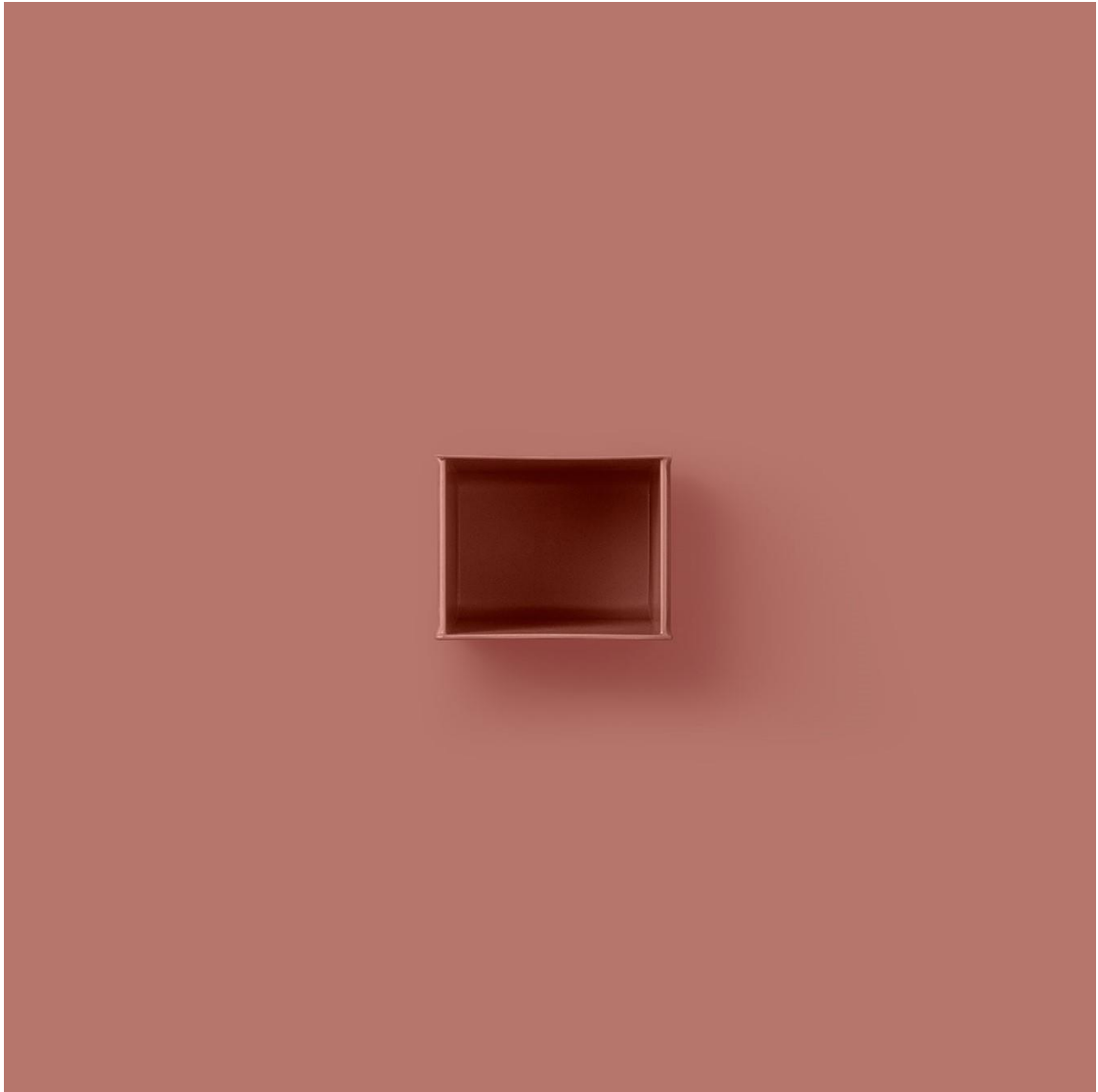

SERIES A3

---

BOX SMALL A3.22

AVAILABLE IN:  
CORAL  
NORDIC GREEN,

THE MATERIAL IS BASED ON STARCH FROM MAIZE AND SWEET POTATO, WITH BAMBOO FIBRE REINFORCEMENT. IT IS NON-TOXIC, NATURALLY DEGRADABLE AND COMPOSIBLE.

DESIGN BY NOTE DESIGN STUDIO

---

[WWW.HAVEN.SE](http://WWW.HAVEN.SE)

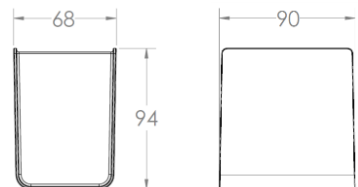

# HAVEN

# A3



SERIES A3

---

BOX LARGE A3.23

AVAILABLE IN:  
NORDIC GREEN,

THE MATERIAL IS BASED ON STARCH FROM MAIZE AND  
SWEET POTATO, WITH BAMBOO FIBRE REINFORCEMENT.  
IT IS NON-TOXIC, NATURALLY DEGRADABLE AND COMPOSIBLE.

DESIGN BY NOTE DESIGN STUDIO

---

[WWW.HAVEN.SE](http://WWW.HAVEN.SE)

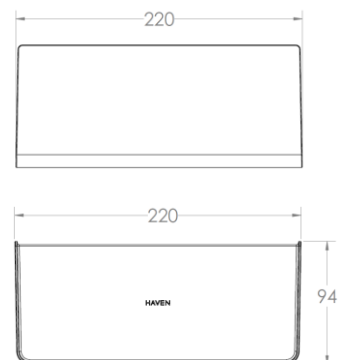

# HAVEN

# A3

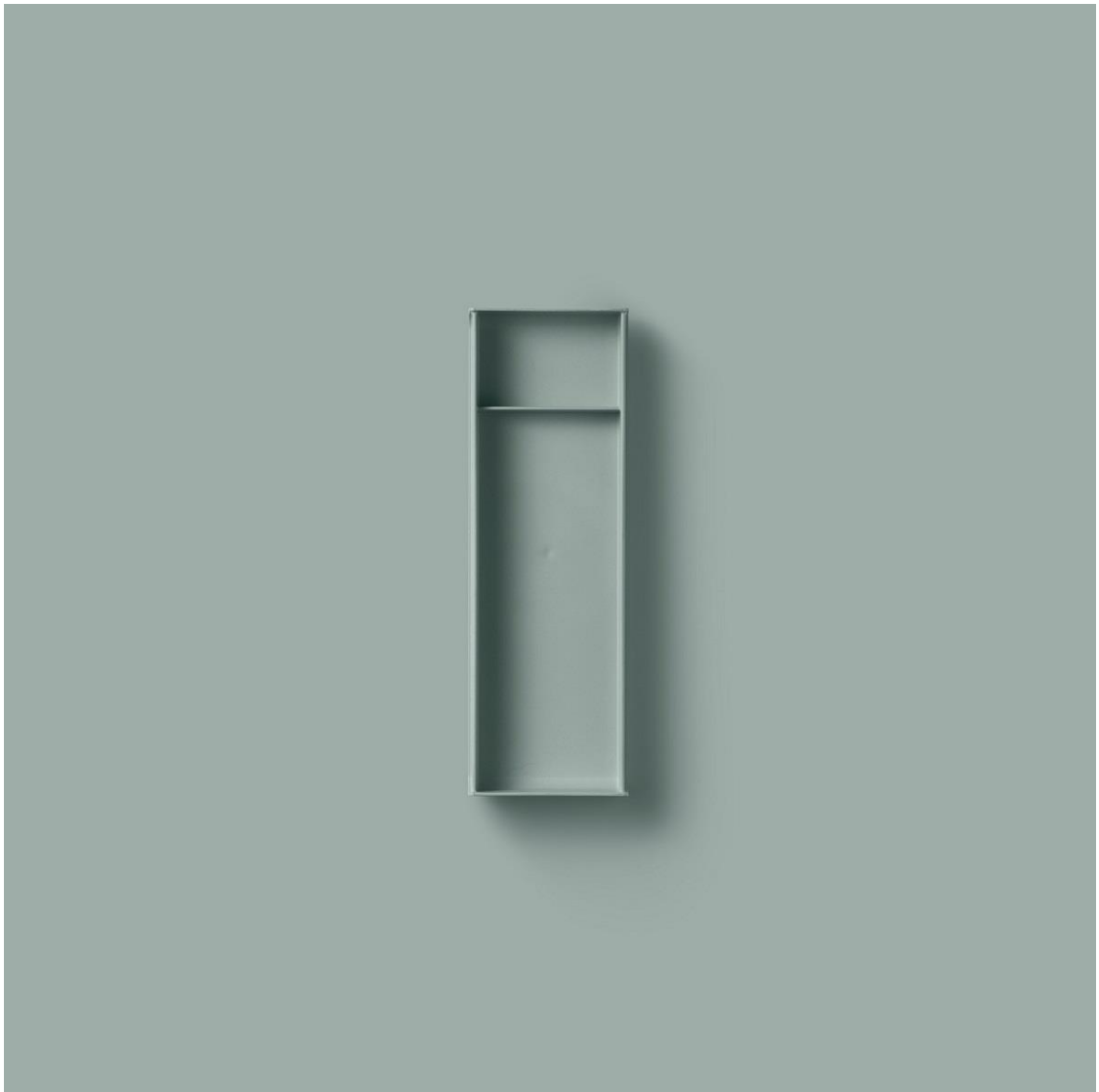

SERIES A3

TRAY A3.24

AVAILABLE IN:  
GREY GREEN  
NORDIC GREEN  
CORAL

THE MATERIAL IS BASED ON STARCH FROM MAIZE AND SWEET POTATO, WITH BAMBOO FIBRE REINFORCEMENT. IT IS NON-TOXIC, NATURALLY DEGRADABLE AND COMPOSTIBLE.

DESIGN BY NOTE DESIGN STUDIO

[WWW.HAVEN.SE](http://WWW.HAVEN.SE)

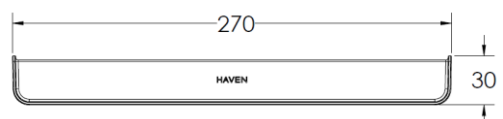
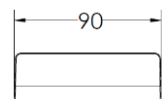

# HAVEN

# A3

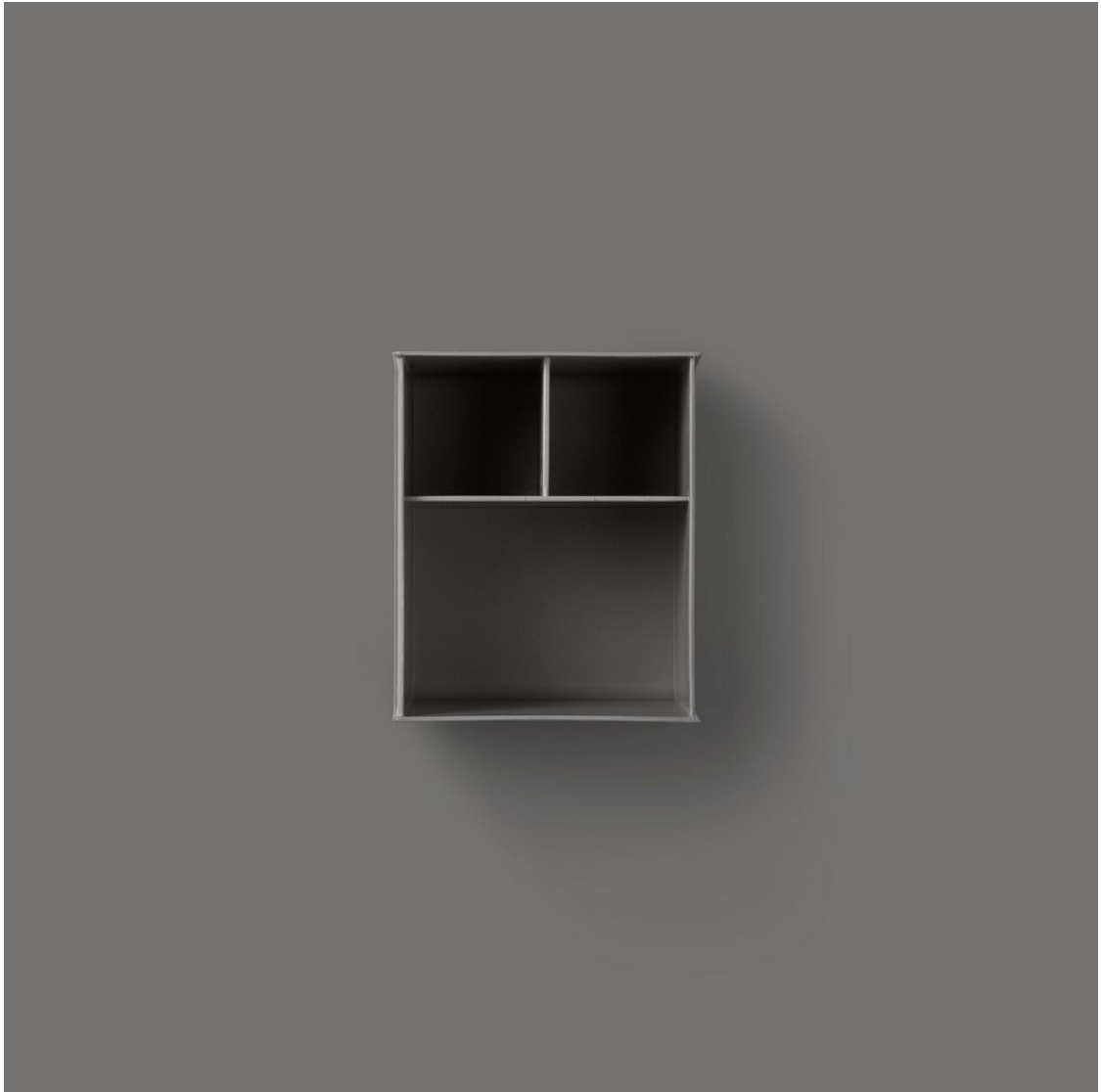

## SERIES A3

---

### BOX SQUARE A3.25

AVAILABLE IN:  
SLATE GREY  
NORDIC GREEN,

THE MATERIAL IS BASED ON STARCH FROM MAIZE AND  
SWEET POTATO, WITH BAMBOO FIBRE REINFORCEMENT.  
IT IS NON-TOXIC, NATURALLY DEGRADABLE AND COMPOSIBLE.

DESIGN BY NOTE DESIGN STUDIO

---

[WWW.HAVEN.SE](http://WWW.HAVEN.SE)

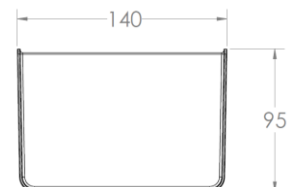
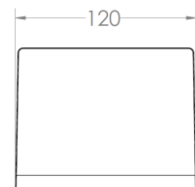

# HAVEN